

# Technisches Datenblatt Spiralgehäuse - Kreiselpumpen

## Serie NM4 Grösse 25

Kennlinien bei	1450 <sup>1</sup> /min.
Motor 4-polig	50 Hz
Wassertemperatur	20 °C

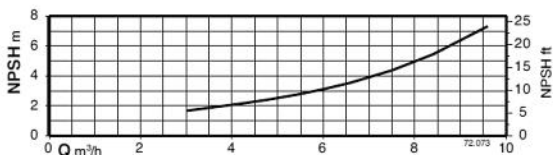
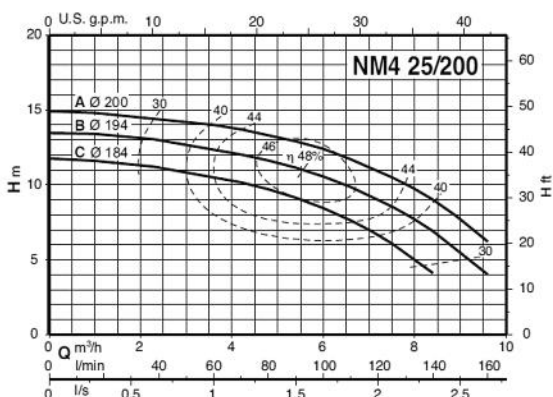
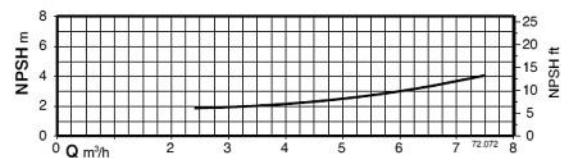
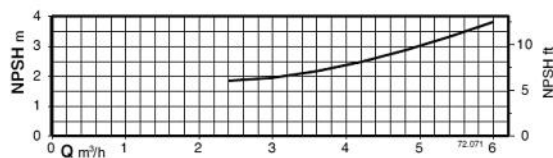
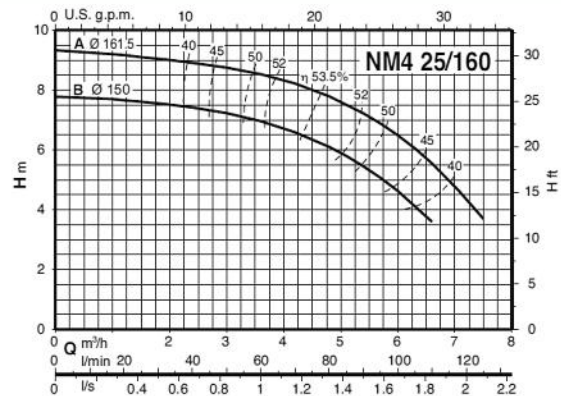
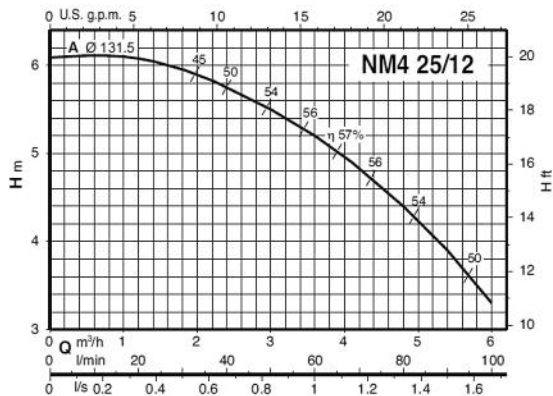

# Massbild NM4 25

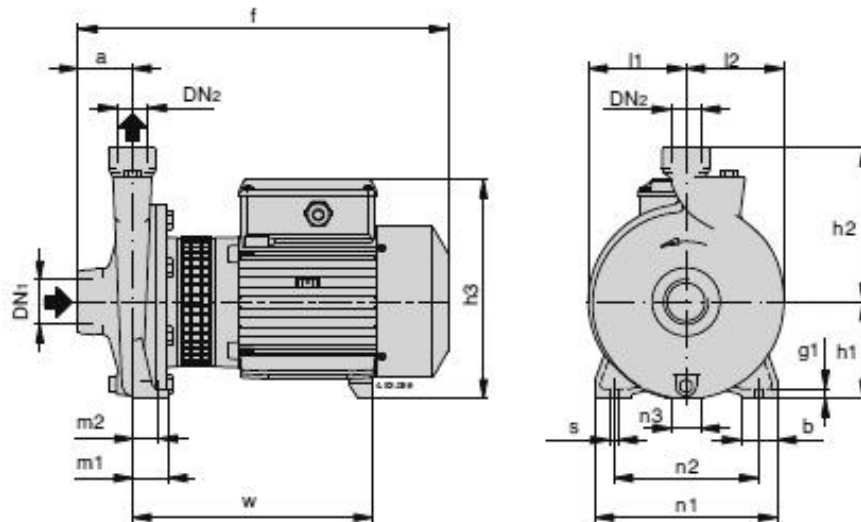

## Pumpenmasse 4 - polig, 1450<sup>1</sup>/min

Pumpentyp	Artikel-Nr.	Abmessungen in mm													Gewicht kg
		a	f	h1	h2	h3	m1	m2	n1	l1	l2	w	DN1	DN2	
NM4 25/12A/A	111.07700	56	313	90	140	199	37.5	27.5	170	85	88	250	G 1 1/2	G 1	13.5
NM4 25/160BE	111.07701	56	380	100	160	228	37.5	27.5	190	102	102	250	G 1 1/2	G 1	17.5
NM4 25/160AE	111.07702	56	380	100	160	228	37.5	27.5	190	102	102	250	G 1 1/2	G 1	17.5
NM4 25/200CE	111.07703	63	385	125	180	253	45	32.5	245	125	125	250	G 1 1/2	G 1	21.5
NM4 25/200BE	111.07704	63	385	125	180	253	45	32.5	245	125	125	250	G 1 1/2	G 1	23
NM4 25/200A/A	111.07705	63	385	125	180	253	45	32.5	245	125	125	250	G 1 1/2	G 1	27

## Motordaten NM4 25, 4-polig, 1450<sup>1</sup>/min

Pumpentyp	Leistung kW	Eingangsstrom in Ampere		
		3~230 V	3~400 V	3~690 V
NM4 25/12A/A	0.25	1.4	0.8	
NM4 25/160BE	0.37	1.65	0.95	
NM4 25/160AE	0.37	1.65	0.95	
NM4 25/200CE	0.37	1.65	0.95	
NM4 25/200BE	0.55	2.6	1.5	
NM4 25/200A/A	0.75	3.3	1.9	



**BRUNNER AG**  
 Brunnergässli 1  
 CH-8302 Kloten  
 Tel. 044 814 17 44  
 Fax 044 814 17 75  
 mail@brunnerpumpen.ch

**BRUNNER AG**  
 Seefeldstrasse 1  
 CH-8280 Kreuzlingen  
 Tel. 079 654 01 48  
 Fax 071 688 82 37  
 www.brunnerpumpen.ch

**BRUNNER SA**  
 Via in Paes 82  
 CH-6572 Quartino  
 Tel. 091 795 21 26  
 Fax 091 795 28 92  
 www.brunnerpompe.ch